

Quick Reference Guide for Analog Silicon Irradiance Sensors



Main data

Irradiance measurement:	up to 1500 W/m ²
Working temperature:	-35 to 80°C
Weight:	appr. 0.4 kg
Measurement cell temperature:	optional

Types

Type	Voltage supply	Irradiance		Cell temperature Signal (-40 to +90°C)
		Signal (0 to 1500 W/m ²)	Temperature compensation	
Si-V-1.5TC-batt Si-V-1.5TC-DMM	Internal Lithium Battery	0 to 1.5	yes	./.
Si-V-1.5TC	4 to 28 VDC	0 to 1.5 V	yes	./.
Si-V-1.5TC-T	5.5 to 28 VDC	0 to 1.5 V	yes	0 to 2 V
Si-mV-85	./.	appr. 85 mV	no	./.
Si-mV-85-Pt100(-4L)	./.	appr. 85 mV	no	Pt100
Si-mV-85-Pt1000(-4L)	./.	appr. 85 mV	no	Pt1000
Si-V-10TC	12 to 28 VDC	0 to 10 V	yes	./.
Si-V-10TC-T	12 to 28 VDC	0 to 10 V	yes	0 to 10 V
Si-I-420TC	12 to 28 VDC	4 to 20 mA	yes	./.
Si-I-420TC-T	12 to 28 VDC	4 to 20 mA	yes	4 to 20 mA

Measurement uncertainty over all aspects, according to GUM (Guide to the Expression of Uncertainty in Measurement), $k = 2$

Irradiance ¹	±5 W/m² ± 2.5 % from rdg. valid perpendicular incidence of the light, spectrum AM 1.5		
Cell temperature	1.1 K	Si-V-1.5TC-T and Si-V-10TC-T	
	1.3 K	Si-I-420TC-T	
	IEC 60751, class A	Si-mV-85-Pt100(-4L) and Si-mV-85-Pt1000(-4L)	

¹ Not valid for Si-mV-85 or Si-mV-85-Pt100/-Pt1000 without external temperature compensation.

User Information

The irradiance sensor is designed for the measurement of the natural solar irradiance. The guarantee is for 1 year from the date of the invoice for the intended use. M&T does not accept any liability for possible losses or damage due to the incorrect usage of the sensor. Liability for consequential damages is excluded.

Special note: The housing for the Si sensors is not allowed to be opened by the installer or user, because, as a consequence, the housing will no longer be sealed after it is closed. If the housing is opened, the manufacturer's warranty will be rendered void.

Maintenance

Scope of the regularly check (at least every 2 years): Cleaning of solar cell, external damage, mechanical fastening, cable laying and any damage to the cable.

In the report IEA-PVPS T13-03:2014 "Analytical Monitoring of Grid-connected Photovoltaic Systems" an interval of 1 to 2 weeks is recommended.

Should damage be found that degrades the function or safety, the sensor is to be replaced.

A recalibration is recommended at least every 3 years.

Wiring Diagram of Analog Si Sensors

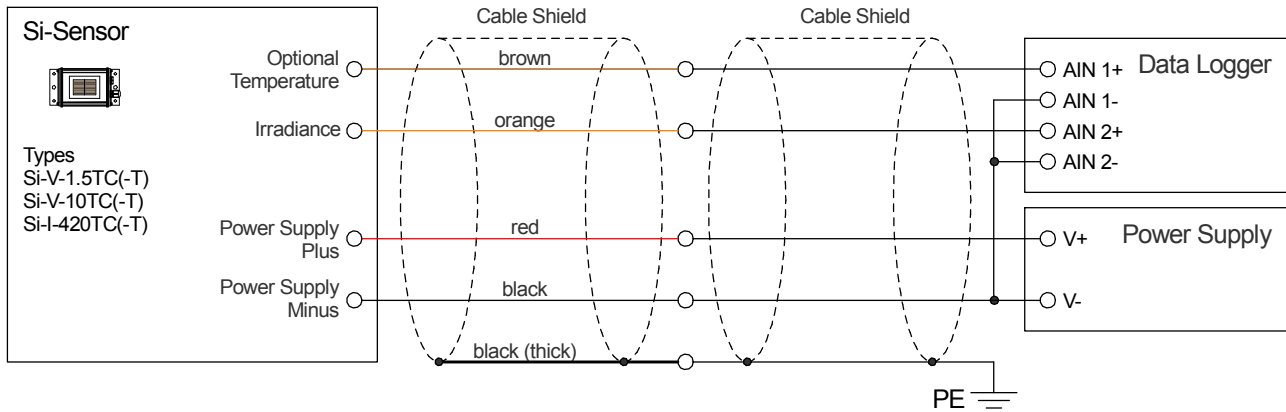

Maximum Additional Cable Length of Si Sensors with 3 m Connection Cable

Sensor type	Cable diameter						
	0.14 mm ²	0.25 mm ²	0.34 mm ²	0.5 mm ²	0.75 mm ²	1.0 mm ²	1.5 mm ²
Si-mV-85	20 m	20 m	20 m	20 m	20 m	20 m	20 m
Si-mV-85-Pt100	/	/	/	/	/	/	/
Si-mV-85-Pt100-4L	20 m	20 m	20 m	20 m	20 m	20 m	20 m
Si-mV-85-Pt1000	5 m	10 m	10 m	15 m	20 m	20 m	20 m
Si-mV-85-Pt1000-4L	20 m	20 m	20 m	20 m	20 m	20 m	20 m
Si-V-1.5TC	50 m	50 m	50 m	50 m	50 m	50 m	50 m
Si-V-1.5TC-T	15 m	30 m	40 m	50 m	50 m	50 m	50 m
Si-V-10TC	100 m	100 m	100 m	100 m	100 m	100 m	100 m
Si-V-10TC-T	50 m	100 m	100 m	100 m	100 m	100 m	100 m
Si-I-420TC	200 m	200 m	200 m	200 m	200 m	200 m	200 m
Si-I-420TC-T	150 m	200 m	200 m	200 m	200 m	200 m	200 m

- Notes: Si-I-420TC(-T): Maximum internal resistance of data logger 200 Ω
- Si-mV-85-Pt100: Maximum 2 K error of temperature measurement due to cable resistance (2 wire connection)
- Si-mV-85-Pt1000: Maximum 1 K error of temperature measurement due to cable resistance (2 wire connection)









Offset and Gradient for Connection to a Datalogger

Units: G in W/m²; U in V (only mV with Si-mV-85(-PT100(0))); I in mA; F₁ in mV / (1000 W/m²); T in °C

Sensor type	Irradiance	Temperature (only with „-T“ or „-Pt100(0)“)
Si-mV-85 Si i-mV-85-Pt100(0)	$G = U / F_1$ with F_1 calibration factor $U = F_1 * G$	Pt100 or Pt1000
Si-V-1.5TC Si-V-1.5TC-T	$G = 1.000 * U$ $U = 0.001 * G$	$T = 65 * U - 40 = 65 * (U - 0.6154)$ $U = 0.0154 * T + 0.6154 = 0.0154 * (T - 40)$
Si-I-420TC Si-I-420TC-T	$G = 93.75 * I - 375 = 93.75 * (I - 4)$ $I = 1/93.75 * G + 4 = (G + 375) / 93.75$	$T = 8.125 * I - 72.5 = 8.125 * (I - 8.923)$ $I = 0.1231 * T + 8.9231 = 0.1231 * (T + 72.5)$
Si-V-10TC Si-V-10TC-T	$G = 150 * U$ $U = 1/150 * G$	$T = 13 * U - 40 = 13 * (U - 3.0769)$ $U = 0.0769 * T + 3.0769 = 0.0769 * (T + 40)$

Correction equation for external temperature compensation of Si-mV-85(-PT100/-PT1000) with voltage U in mV:

$$G = U / \{F_1 * [1 + 0.0005 * (T - 25°C)]\}$$

	<p>Si sensors used for monitoring of PV installations must be installed with the same alignment and inclination as the PV generator. The mounting location should be free of shading as far as possible. To facilitate maintenance and cleaning of the Si sensor, the Si sensor should be mounted in an easily accessible place (e.g. near roof windows or skylights).</p>
	<p>The mounting location at a PV generator must be selected such that snow cannot jeopardise the Si sensor as it slides off. For this reason do not mount along the drip edge on the PV generator.</p>
	<p>The connecting cable should always be laid separated from, e.g. main DC cables or AC cables. The connecting cable is to be laid so it is fixed. The minimum bending radius of 15 x cable diameter (ø approx. 5 mm) is to be observed. The voltage drop at the cable has to be considered when calculating the maximum cable length.</p>
	<p>The pressure equalisation element must not be damaged. The cable gland is not allowed to be undone or tightened by the user. It is not necessary for the installer or user to open the Si sensor. If the housing is nevertheless opened, no liability for the sealing can be accepted.</p>
	<p>The surge protection concept must be adapted to the specific local situation. This means, for instance, that the measuring cables must be equipped with a separate surge arrester at the entry to a building. The sensor must be integrated into the lightning protection concept.</p>
	<p>The sensors are designed for safety extra-low voltage (SELV) operation. Reversing the polarity or mixing up the connections on the Si sensor may cause irreversible damage to the sensor. The cable shield is to be connected to PE during installation.</p>
	<p>The installation and assembly of electrical equipment must be carried out by electrically qualified persons. The sensor may not be used with equipment whose direct or indirect purpose is to prevent human death or injury, or whose operation poses a risk to humans, animals or property.</p>
	<p>Mortal danger due to electrical power On the connection of the Si sensor to an inverter, dangerous voltages are present on the inverter (disconnection, secure against switching, follow inverter manual).</p>
	<p>Should it be necessary to clean the Si sensor, a soft cotton cloth, water and a mild cleaning agent can be used for this purpose.</p>

Dimension

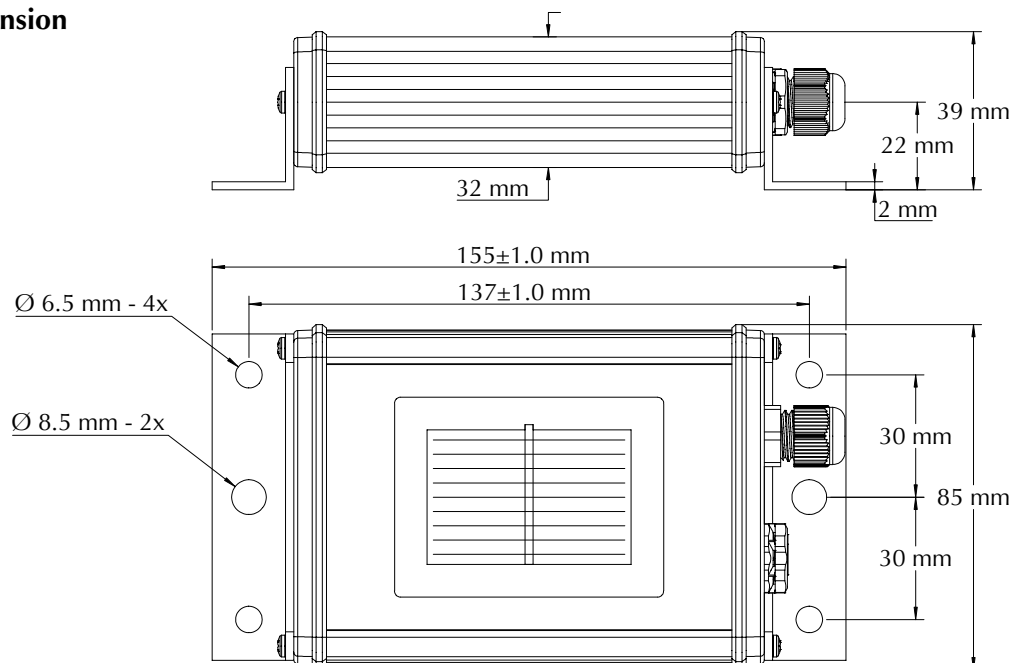

Mounting Instruction

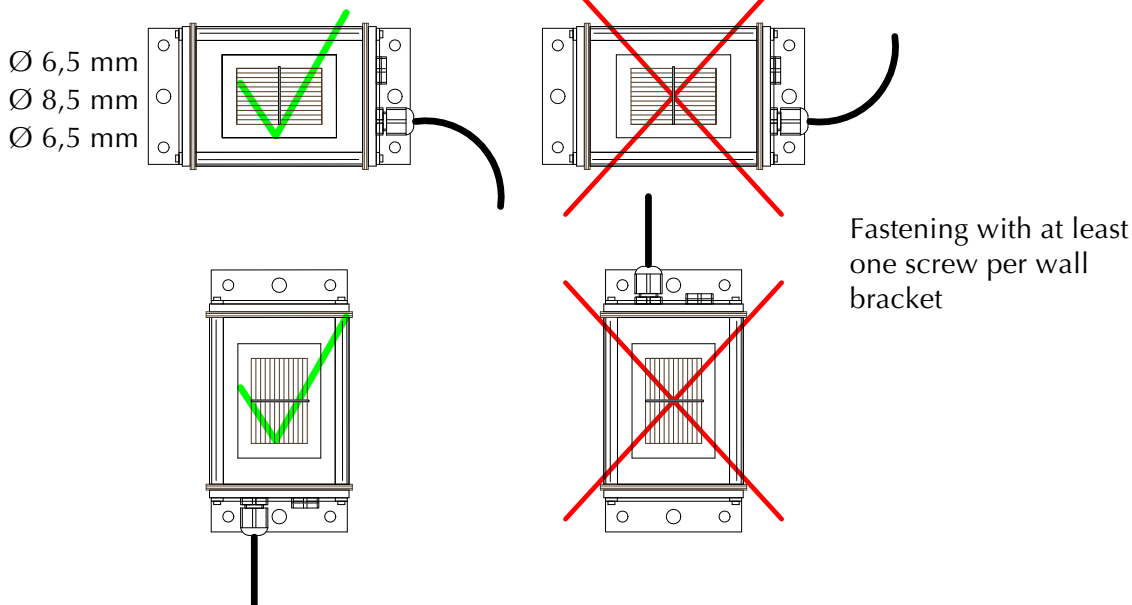

Technical Data

General Data				
Solar cell	Monocrystalline silicon; 50 mm x 33 mm			
Housing	Material	Powder-coated aluminium		
	Dimension / Weight	155 mm x 85 mm x 39 mm / appr. 350 g		
	Degree of protection	IP 65		
Operating temperature	-35 to +80°C			
Sensor cable	LiYC11Y 4 x 0.14 mm ² UL20233; length typical 3 m			
Customs tariff number	85 41 40 90			
Electrical Data of Si-V-1.5TC, Si-V-1.5TC-T and Si-mV-85(-Pt100/-Pt1000)				
	Si-V-1.5TC	Si-V-1.5TC-T	Si-mV-85-XXX	
Supply voltage	24 VDC (4 to 28 VDC)	24 VDC (5.5 to 28 VDC)	None	
Max. current consumption	1 mA	2 mA	./.	
Load	Minimum 100 kΩ (for Si-V-1.5TC-batt minimum 1 MΩ)			
Electrical Data of Si-V-10TC, Si-V-10TC-T, Si-I-420TC and Si-I-420TC-T				
	Si-V-10TC	Si-V-10TC-T	Si-I-420TC	Si-I-420TC-T
Supply voltage	24 VDC (12 to 28 VDC)		24 VDC (12 to 28 VDC)	
Max. current consumption	1 mA	1 mA	25 mA	50 mA
Load	Minimum 100 kΩ		Maximum 400 Ω	
Wire Colour	Si-V-XXX, Si-I-XXX	Si-mV-85(-Pt100/-Pt1000)	Si-mV-85-Pt100-4L/-Pt1000-4L	
Orange	Irradiance (plus)	Irradiance (plus)	Irradiance (plus)	
Brown	Temperature (plus)	Temperature - 1	Temperature - 1	
Black	Minus	Irradiance (Minus)	Irradiance (Minus)	
Red	Supply (plus)	Temperature - 2	Temperature - 2	
Black (thick)	Shield	Shield	Shield	
Yellow (only „-4L“)	./.	./.	Temperature - 1	
Green (only „-4L“)	./.	./.	Temperature - 2	

Items Supplied:

- Si sensor incl. pre-assembled connecting cable or suitable male connector
- Calibration record
- Quick reference guide

Please read also the installation and operating instruction (newest version on www.ib-mut.de).